

Article number: 201134002

Description: E+G Guide bush DIN 172-B2-9-A
with collar

Measures

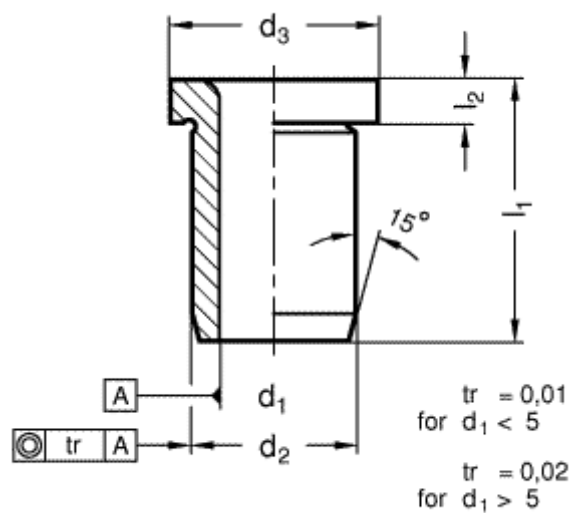

d1 = 2

d2 = 5

d3 = 8

l1 = 9

l2 = 2